

**INSTALLATION INSTRUCTION #1E**

**THERMOCABLE® FLUOROPOLYMER INSULATED  
PARALLEL HEATING CABLE**

**TERMINATION KIT # A1333-COJ**

**SPLICE KIT # S1334-COJ**

**END TERMINATION KIT # E1336-COJ**

**POWER SPLICE KIT # PS1337-12-COJ**

THERMOCABLE® parallel heating strip is used to prevent GF Urecon pre-insulated pipes from freezing.

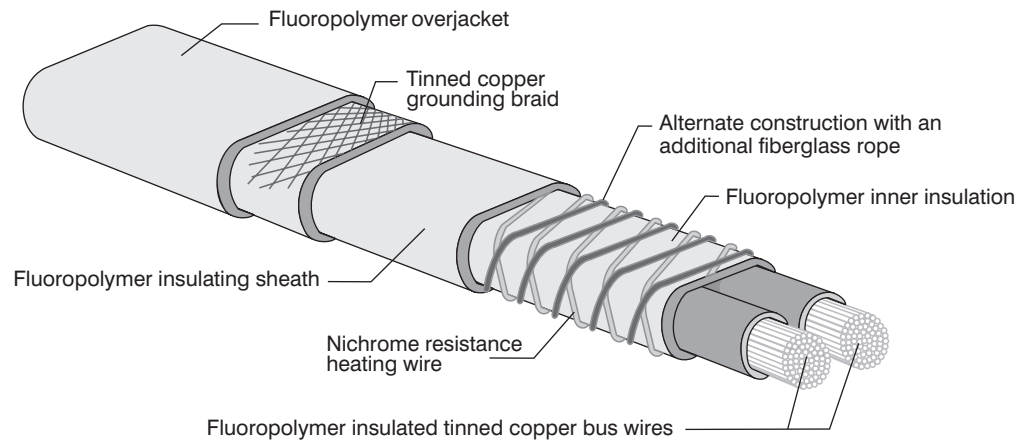

THERMOCABLE® fluoropolymer constant watt cut - to - length heat tracing cable is a parallel resistance type heating strip which uses a thermally stable nichrome heating wire, with a series of heating zones. These heating zones produce constant, predictable wattage per meter output. THERMOCABLE® is ideally suited for pulling into trace conduits on GF Urecon pre-insulated pipe systems.

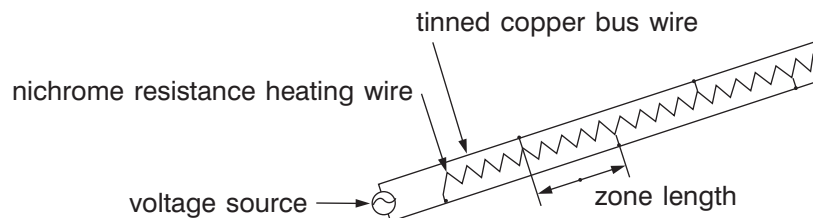

**PROPER HEATING CABLE SELECTION :**

GF Urecon can assist you in determining the required heating cable for your application. We have computer design programs to calculate the power requirement of a given pipe/insulation arrangement. The following heat loss charts can also enable you to determine the proper heating cable power output required for your application. These charts are for urethane insulation.

Select the heat loss chart with a temperature differential ( $\Delta T$ ) similar or greater than of the proposed installation. The temperature differential ( $\Delta T$ ) is the temperature difference between the minimum ambient and the desired maintain temperatures of the pipe.

Nominal pipe size		Pipe heat loss @ 10 °C (18 °F) $\Delta T$					
		Urethane insulation thickness					
mm	in	25 mm (1 in)		50 mm (2 in)		75 mm (3 in)	
		w/m	w/ft	w/m	w/ft	w/m	w/ft
13	1/2	1.5	0.5	1.0	0.3	0.9	0.3
19	3/4	1.7	0.5	1.2	0.4	0.9	0.3
25	1	2.0	0.6	1.3	0.4	1.1	0.3
32	1 1/4	2.3	0.7	1.5	0.5	1.2	0.4
40	1 1/2	2.5	0.8	1.6	0.5	1.3	0.4
50	2	3.0	0.9	1.8	0.5	1.4	0.4
64	2 1/2	3.4	1.0	2.1	0.6	1.6	0.5
75	3	4.0	1.2	2.4	0.7	1.8	0.5
100	4	4.9	1.5	2.8	0.9	2.1	0.6
150	6	6.8	2.1	3.8	1.2	2.8	0.9
200	8	8.6	2.6	4.7	1.4	3.4	1.0
250	10			5.7	1.7	4.1	1.2
300	12			6.6	2.0	4.7	1.4
350	14			7.2	2.2	5.1	1.6
400	16			8.1	2.5	5.7	1.7
450	18			9.0	2.7	6.3	1.9
500	20			9.9	3.0	6.9	2.1
550	22			10.8	3.3	7.5	2.3
600	24			11.7	3.6	8.1	2.5

Nominal pipe size		Pipe heat loss @ 20 °C (36 °F) $\Delta T$					
		Urethane insulation thickness					
mm	in	25 mm (1 in)		50 mm (2 in)		75 mm (3 in)	
		w/m	w/ft	w/m	w/ft	w/m	w/ft
13	1/2	3.0	0.9	2.1	0.6	1.7	0.5
19	3/4	3.4	1.0	2.3	0.7	1.9	0.6
25	1	3.9	1.2	2.6	0.8	2.1	0.6
32	1 1/4	4.6	1.4	2.9	0.9	2.4	0.7
40	1 1/2	5.0	1.5	3.2	1.0	2.5	0.8
50	2	5.9	1.8	3.7	1.1	2.9	0.9
64	2 1/2	6.8	2.1	4.1	1.2	3.2	1.0
75	3	8.0	2.4	4.7	1.4	3.6	1.1
100	4	9.8	3.0	5.7	1.7	4.3	1.3
150	6	13.7	4.2	7.6	2.3	5.6	1.7
200	8	17.3	5.3	9.5	2.9	6.8	2.1
250	10			11.4	3.5	8.1	2.5
300	12			13.2	4.0	9.4	2.9
350	14			14.4	4.4	10.1	3.1
400	16			16.2	4.9	11.3	3.4
450	18			18.0	5.5	12.6	3.8
500	20			19.8	6.0	13.8	4.2
550	22			21.6	6.6	15.0	4.6
600	24			23.4	7.1	16.2	4.9

Nominal pipe size		Pipe heat loss @ 30 °C (54 °F) $\Delta T$					
		Urethane insulation thickness					
mm	in	25 mm (1 in)		50 mm (2 in)		75 mm (3 in)	
		w/m	w/ft	w/m	w/ft	w/m	w/ft
13	1/2	4.4	1.3	3.1	0.9	2.6	0.8
19	3/4	5.1	1.6	3.5	1.1	2.8	0.9
25	1	5.9	1.8	3.9	1.2	3.2	1.0
32	1 1/4	6.8	2.1	4.4	1.3	3.5	1.1
40	1 1/2	7.5	2.3	4.8	1.5	3.8	1.2
50	2	8.9	2.7	5.5	1.7	4.3	1.3
64	2 1/2	10.2	3.1	6.2	1.9	4.8	1.5
75	3	12.0	3.7	7.1	2.2	5.4	1.6
100	4	14.7	4.5	8.5	2.6	6.4	2.0
150	6	20.5	6.2	11.5	3.5	8.4	2.6
200	8	25.9	7.9	14.2	4.3	10.3	3.1
250	10			17.1	5.2	12.2	3.7
300	12			19.8	6.0	14.1	4.3
350	14			21.6	6.6	15.2	4.6
400	16			24.3	7.4	17.0	5.2
450	18			27.0	8.2	18.8	5.7
500	20			29.7	9.1	20.7	6.3
550	22			32.4	9.9	22.5	6.9
600	24			35.1	10.7	24.3	7.4

Nominal pipe size		Pipe heat loss @ 40 °C (72 °F) $\Delta T$					
		Urethane insulation thickness					
mm	in	25 mm (1 in)		50 mm (2 in)		75 mm (3 in)	
		w/m	w/ft	w/m	w/ft	w/m	w/ft
13	1/2	5.9	1.8	4.1	1.2	3.4	1.0
19	3/4	6.8	2.1	4.6	1.4	3.8	1.2
25	1	7.8	2.4	5.2	1.6	4.2	1.3
32	1 1/4	9.1	2.8	5.9	1.8	4.7	1.4
40	1 1/2	10.0	3.0	6.4	2.0	5.1	1.6
50	2	11.8	3.6	7.3	2.2	5.7	1.7
64	2 1/2	13.7	4.2	8.3	2.5	6.4	2.0
75	3	16.0	4.9	9.5	2.9	7.2	2.2
100	4	19.6	6.0	11.4	3.5	8.5	2.6
150	6	27.3	8.3	15.3	4.7	11.2	3.4
200	8	34.6	10.5	19.0	5.8	13.7	4.2
250	10			22.8	6.9	16.3	5.0
300	12			26.5	8.1	18.7	5.7
350	14			28.7	8.7	20.3	6.2
400	16			32.4	9.9	22.7	6.9
450	18			36.0	11.0	25.1	7.7
500	20			39.6	12.1	27.5	8.4
550	22			43.2	13.2	30.0	9.1
600	24			46.8	14.3	32.9	10.0

Nominal pipe size		Pipe heat loss @ 50 °C (90 °F) ΔT					
		Urethane insulation thickness					
mm	in	25 mm (1 in)		50 mm (2 in)		75 mm (3 in)	
		w/m	w/ft	w/m	w/ft	w/m	w/ft
13	1/2	7.4	2.3	5.2	1.6	4.3	1.3
19	3/4	8.5	2.6	5.8	1.8	4.7	1.4
25	1	9.8	3.0	6.5	2.0	5.3	1.6
32	1 1/4	11.4	3.5	7.4	2.3	5.9	1.8
40	1 1/2	12.5	3.8	8.0	2.4	6.3	1.9
50	2	14.8	4.5	9.1	2.8	7.2	2.2
64	2 1/2	17.1	5.2	10.4	3.2	8.0	2.4
75	3	20.0	6.1	11.8	3.6	9.0	2.7
100	4	24.5	7.5	14.2	4.3	10.7	3.3
150	6	34.2	10.4	19.1	5.8	14.0	4.3
200	8	43.2	13.2	23.7	7.2	17.1	5.2
250	10			28.5	8.7	20.4	6.2
300	12			33.1	10.1	23.4	7.1
350	14			35.9	10.9	25.3	7.7
400	16			40.5	12.3	28.4	8.7
450	18			45.0	13.7	31.4	9.6
500	20			49.5	15.1	34.4	10.5
550	22			54.0	16.5	37.4	11.4
600	24			58.6	17.9	40.5	12.3

Nominal pipe size		Pipe heat loss @ 60 °C (108 °F) ΔT					
		Urethane insulation thickness					
mm	in	25 mm (1 in)		50 mm (2 in)		75 mm (3 in)	
		w/m	w/ft	w/m	w/ft	w/m	w/ft
13	1/2	8.9	2.7	6.2	1.9	5.2	1.6
19	3/4	10.2	3.1	6.9	2.1	5.7	1.7
25	1	11.7	3.6	7.8	2.4	6.3	1.9
32	1 1/4	13.7	4.2	8.8	2.7	7.1	2.2
40	1 1/2	15.1	4.6	9.6	2.9	7.6	2.3
50	2	17.7	5.4	11.0	3.4	8.6	2.6
64	2 1/2	20.5	6.2	12.4	3.8	9.6	2.9
75	3	23.9	7.3	14.2	4.3	10.9	3.3
100	4	29.4	9.0	17.0	5.2	12.8	3.9
150	6	41.0	12.5	22.9	7.0	16.8	5.1
200	8	51.9	15.8	28.4	8.7	20.5	6.2
250	10			34.2	10.4	24.4	7.4
300	12			39.7	12.1	28.1	8.6
350	14			43.1	13.1	30.4	9.3
400	16			48.5	14.8	34.0	10.4
450	18			54.0	16.5	37.7	11.5
500	20			59.4	18.1	41.3	12.6
550	22			64.8	19.8	44.9	13.7
600	24			70.3	21.4	48.6	14.8

Based on the pipe size and insulation thickness, find the corresponding heat loss value in the table. This value, expressed in watts / meter (*watts / foot*), will indicate the minimum power required.

Insulation type	Insulation "K" factor (BTU•in/ft <sup>2</sup> •hr•°F)	Correction factor (multiplier)
Urethane foam	0.17	1.00
Polyisocyanurate	0.18	1.06
Fiberglass	0.25	1.47
Mineral wool	0.30	1.76
Calcium silicate	0.37	2.18
Cellular glass	0.40	2.35

If the insulation used is not urethane foam, this pipe heat loss value has to be adjusted accordingly. Other types of insulation are not as efficient and require more power to achieve the same results. Refer to the above table to determine the correction factor corresponding to the insulation used. Multiply the heat loss obtained initially by that correction factor. Select a heating cable power output with at least that much power.

**Caution :** On plastic pipe, the heating cable power output is limited to 13 watts/meter (*4 watts/foot*) when using the standard 65 °C (*149 °F*) high limit cutout setting on the thermostat. If the power requirement of your piping system is greater than this limit of 13 watts/meter (*4 watts/foot*), multiple runs of lower wattage heating cables totaling the power requirement must be used.

In certain cases, a 16 watts/meter (*5 watts/foot*) cable can be used if the high limit cutout setting on the thermostat is raised. Please contact a GF Urecon office for details.

THERMOCABLE® is provided with a metallic grounding braid conforming to the latest electrical codes, a fluoropolymer over jacket is also provided to ease the pulling into conduits.

This heating cable can be used on any type of metal or plastic pipe. It is available in several watt densities and voltages as indicated in the following table (page 4).

All cables except C8-120-COJ have # 12 AWG bus wires, C8-120-COJ is intended for short runs (house services) and has #16 AWG bus wires. Be sure that you are using the proper termination or splice kit before commencing installation.

**GF URECON THERMOCABLE® CONSTANT WATT TRACE CABLE FOR PRE-INSULATED PIPES**

Part number	Color	Watts		Volts	Bus wire AWG	Maximum circuit length		Approximate zone length	
		per meter	per foot			meters	feet	cm	inches
<b>120 VOLT THERMOCABLE®</b>									
C7-120-COJ	Blue	7	2	120	12	140	450	92	36
C8-120-COJ	Red	8	2.4	120	16	80	275	92	36
C13-120-COJ	Yellow	13	4	120	12	125	400	61	24
<b>240 VOLT THERMOCABLE®</b>									
C10-240-COJ	Green	10	3	240	12	245	800	152	60
C13-240-COJ	Red	13	4	240	12	245	800	127	50
C20-240-COJ	Orange	20	6	240	12	200	650	107	42
C26-240-COJ	White	26	8	240	12	175	570	92	36
<b>575 VOLT THERMOCABLE®</b>									
C13-575-COJ	Clear	13	4	575	12	425	1400	183	72
C20-575-COJ	Violet	20	6	575	12	365	1200	183	72

**NOTE:**

Alternate voltages: should THERMOCABLE® be connected to less (or more) than its rated voltage, the actual thermal output will be reduced or increased. Calculate the actual thermal output as follows:

$$\text{ACTUAL THERMAL OUTPUT} = \frac{\text{CONNECTED VOLTAGE}^2}{\text{RATED VOLTAGE}^2} \times \text{THERMOCABLE}^{\circledR} \text{ RATED THERMAL OUTPUT}$$

**ACCESSORIES FOR THERMOCABLE®:**

A1333-COJ	Power and end termination kit for THERMOCABLE®.
S1334-COJ	In-line splice kit for THERMOCABLE®.
E1336-COJ	Three-pack end termination kit for all THERMOCABLE®.
PS1337-12-COJ	Splice kit for #12 AWG bus wires THERMOCABLE® to power leads.
A-300	Aluminum tape roll 5 cm (2 in) wide x 45 m (150 ft) long.

**NOTE:**

Only GF Urecon electrical accessories such as power terminations, end terminations and splices are certified for use with THERMOCABLE®.

GF Urecon THERMOCABLE® and accessories are CSA certified to standard C22.2 No. 130-03 for use in non-hazardous locations for the following usage codes:

-S : with weather resistance.

-W : with wet rating

## INSTALLATION OF THERMOCABLE® IN A TRACE CONDUIT ON GF URECON PRE-INSULATED PIPE:

When the pre-insulated pipe has been joined, the urethane block should be removed (bell and spigot systems) or the cutback area at each connection should be left exposed to assist in the installation of the heat tracing cable.

If the pipe is to be buried and the trench is dry, the pipe can be laid in the trench. The joint area should be accessible from underneath to permit the later installation of the heat shrink wrap. If the trench is wet then the pipe should be left in a dry area, on the side of the trench until the cable has been installed (polyethylene pipe with butt fused joints only).

**Before inserting the cable the following items should be considered:**

Read the Thermocable® as well as the Power Feed Kit (if applicable) installation instructions thoroughly before commencing the installation.

Inspect the heating cable packaging to ensure that no damage occurred in transit.

Perform an insulation resistance test (minimum 500 Vdc) at each of the following stages: prior to the cable installation,

once the cable has been pulled through the channel and after the thermal insulation installation is complete. The test should be done between each cable conductor and the grounding braid. Each test should be done for a period of one (1) minute at the end of which there should not be any fluctuation in the readings.

The insulation resistance reading should be of several hundreds to thousands megohms (depending on instrument's accuracy). The installation/environment will influence the readings. A dry, clean installation will provide the best results.

These values should be recorded in the commissioning log for future reference (page 12).

The positions of the power points should be located and marked along the route and should not exceed the maximum circuit length of the Thermocable® used, taking into consideration the extra cable allowance required for flanges, valves, etc. as described in the table below. It is usually most convenient to position power points at pipe connections. This will eliminate the need to penetrate the insulation somewhere between pipe joints.

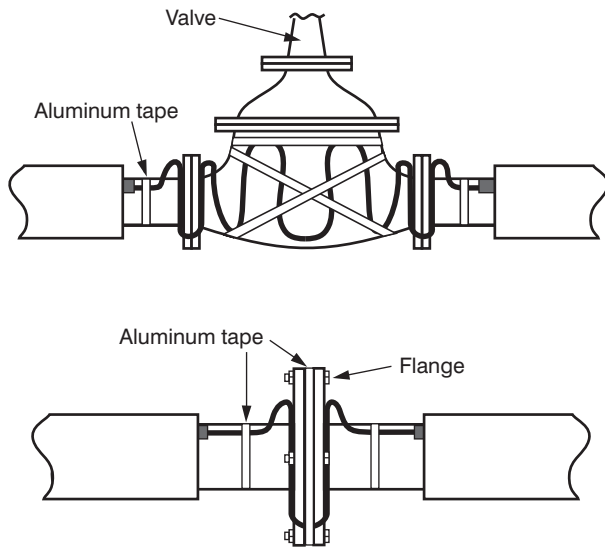

**EXTRA CABLE ALLOWANCE**

Nominal pipe size		Flange (pair)		Gate valve	
mm	in	cm	in	cm	in
13	1/2	23	9	30	12
19	3/4	23	9	30	12
25	1	30	12	30	12
32	1 1/4	30	12	38	15
40	1 1/2	38	15	46	18
50	2	38	15	61	24
64	2 1/2	46	18	61	24
75	3	46	18	76	30
100	4	61	24	91	36
150	6	61	24	107	42
200	8	76	30	122	48
250	10	91	36	137	54
300	12	107	42	152	60
350	14	122	48	168	66
400	16	137	54	183	72
450	18	168	66	213	84
500	20	183	72	229	90
550	22	198	78	229	90
600	24	213	84	244	96

---

The proper voltage and correct thermostats should be available for each power point. It is useful to provide a numbering system for the power points and to assign these numbers to the appropriate electrical components. Follow the engineer's tracing layout drawing if one exists. The correct heat tracing cable must be selected for each pipe and power point. Extra care must be taken to ensure that the heating cables are installed correctly, and that the correct wattage and voltage cable has been selected for installation. **Caution, verify the identifying print on the cable before installing it into the conduit. Never connect the wrong voltage to the cable.**

The Canadian Electrical Code requires that Ground Fault protection be used on all heating cables. When using a mechanical thermostat such as GF Urecon URTH series of thermostats, the installer has to provide a ground-fault circuit breaker meant for equipment protection (30 mA setting). If a UTC series electronic thermostat is used, the electronics of the thermostat have inherent Ground Fault detection circuitry to meet code requirements.

Ensure that the final position of the conduit, after the pipe has been installed, is clearly identified. Usually the conduit is positioned on the top of the pipe if it will normally be full of liquid. If the pipe is normally only partially full, the conduit should be installed in the lower quadrant. If the pipe is to be moved after installation of the cable and after covering the joint areas, it will be necessary to mark the position of the conduit on the insulation jacket. When the pipe is in its final position this mark should be in the correct position, either on top, or in the lower quadrant depending on the pipe service.

The conduit should be inspected prior to cable pulling to ensure that it is free of debris, obstructions and standing water.

**The following steps describe the preferred method for inserting the heat tracing cable, at least two workers are required.**

1. Pull a few feet of cable from the reel and install a heat shrink end cap (for moisture sealing as per the instructions on page 9). Note: On small heat trace channels, the heat shrink tube has to be installed after the cable has been pulled (step 5).

2. Push the end cap into the conduit at the power point position and continue pushing the cable until it emerges at the first cutback area. Pay off the cable from the reel so that it does not twist or kink. This can be simplified by mounting the cable reel on a pair of wooden "horses". While the cable is paying off the reel examine it for cuts, "bruises" or any other defects. Defects should be removed and the cables spliced using a THERMOCABLE® splice kit. If the cable is difficult to push, retract it, cup some powder lubricant (talc) in one hand and apply it to the cable while pushing. If this does not solve the problem insert a "fish tape" through the conduit from the opposite end and attach it to the cable. Use a combined push and pull to insert the cable. If this is not successful it will be necessary to cut open the pipe insulation and remove the obstruction.
3. As the end of the cable emerges at the first cut-back area, the second worker gently pulls the cable forward.
4. Insert the end cap into the conduit on the next length of pipe and continue the insertion method. In this manner the cable can be "threaded" from one length to the next until the heating circuit has been completely installed.
5. Verify that the end cap has not been damaged during the threading operation, if it has, cut it off and install a new one. Be sure that the bus wires are NOT TOUCHING. If the end cap is in good condition, it is now time to install the heat shrink tube if this was not done in step 1.
6. It is more convenient to terminate the heat tracing cable circuit at a pipe connection. It allows for easier access in the event that maintenance is required. The section of cable between the last indentation and the end cap is non-heating. The "cold" end on the next cable circuit can be over-lapped at this position to ensure continuous heating. If the cable circuit is to be terminated within a pipe length between two connections ensure that the "cold end" on the cable is as short as possible. The position of the end of each circuit should be noted on the "as-built" drawings and with a solid stake driven into the ground beside the pipe.

- 
7. The next cable circuit in the same direction down the pipeline should be installed from the next power point position in the same manner as previously described. When it is inserted into the final length of pipe its length should be adjusted by moving up more “slack” and by cutting the cable and repositioning the end cap.
  8. Power feed kits and temperature sensor(s) must be installed at this time according to their specific installation instructions. After the pipe and cable have been subjected to the specified acceptance tests and recorded in the commissioning log, the insulation at the pipe connections can be completed and heat shrink sleeves installed.
  9. The commissioning log should become part of the “as built” records after being witnessed by the owner.
  10. Install the standard insulation half shells tightly over the cutback area, line up the groove in the halfshell over the conduit ends and cable (or insert the urethane block on bell and spigot systems).
  11. Wrap the heat shrink sleeve around the half shells (or urethane block) and shrink into place. If the pipe has a metal jacket, cover the halfshell with the pre-rolled metal cover supplied, caulking all seams against water ingress.

#### **AVOID DAMAGE TO HEATING CABLE AND PREVENT POSSIBLE FREEZING BY:**

- Handling with normal care, when pulling in long circuits avoid walking or driving over cable during and after installation.
- Never using a mechanical pulling device (winch, etc.).
- Not bending to a diameter of less than 50 mm (2 in).
- Not installing the heating cable when the ambient temperature is below -40 °C (-40 °F).
- Not installing the Power termination, splice or End termination when the ambient temperature is below 0 °C (32 °F).
- If connected to generated power, avoiding high voltage spikes (especially on 575 V circuits).

- Never using THERMOCABLE® for internal tracing (inside the pipe).
- Not exceeding the maximum circuit length as indicated in the table on page 4.

#### **CUTTING THE HEATING CABLE IN THE PROPER LOCATION:**

- It is important to understand how the cable works and to locate the indents (nodes) where the nichrome heating element alternately makes contact with the bus wires. If not cut at the correct location, a ‘dead zone’ may occur causing small diameter pipes to freeze, or for the controller high temperature limit sensor to be installed on a ‘dead zone’ possibly causing damage to the pipe, if plastic. Follow the ‘cutting’ instructions carefully as described for each kit.

#### **YOU CAN ENSURE THAT YOU HAVE A RELIABLE SYSTEM BY:**

- Installing the correct wattage cable on the proper pipe (cables are color coded for easy identification).
- Connecting the correct voltage to the cable to produce the desired wattage.
- Having no heating cable installed closer than 13 mm (1/2 in) of any exposed combustible surface.
- Always using a thermostat to control the cable.
- Always using a dual sensing electronic thermostat with high temperature cutout on plastic pipes (high temperature cutout setting should be verified with GF Urecon).
- Installing the thermostat as per its specific installation instructions taking special care to ensure that the high cable temperature sensor (when required) is securely attached to an **ACTIVE** heating zone of the heating cable. On small diameter piping (100 mm (4 in)  $\varnothing$  and less), the controlling sensor has to be securely attached to the pipe 180 ° away from the heating cable. In the case of larger diameter pipes, the controlling sensor has to be securely attached to the pipe away from the heating cable by at least 15 cm (6 in). You have to ensure that the controlling sensor(s) are against the pipe wall and **UNDER THE INSULATION**.

- Having the controlling temperature sensor(s) located on the coldest portion of the piping. The specifier/installer has to evaluate the layout of the piping system and determine the location of the coldest ambient temperature surrounding the pipe based on; quantity of snow cover, variation in depth of bury, portion of piping under a roadway etc.
- Not energizing before the installation is complete.
- Installing the heating cable in a way that it is not crossed, grouped or touching itself.
- Ensuring the heating cable is not applied to various diameters of pipe (or a network) and controlled from one controller (because of varying heat loss, each pipe diameter normally requires a separately controlled tracer).
- Ensuring that the heating cable is not trapped by insulation, especially where half shells are applied at pipe joints or at fittings, particular caution must be exercised when field sprayed foam is applied.
- Never connecting power while the heating cable is on the reel, or in the shipping container.

#### **IMPORTANT REMINDER:**

- Prior and after installation, check the heating cable with a 500 Vdc (minimum) insulation tester (megger) between each conductor and grounding braid.
- After installation using a multimeter, measure the cable resistance and record in the commissioning log for future reference (page 12).
- Metal structures or materials used for the support of, or on which the heating cable is installed, shall be grounded in accordance with section 10 of the Canadian Electrical Code, Rule 62-310(3). The grounding braid must also be electrically grounded at the power source.

#### **BEFORE YOU START:**

Parallel heating sets are field assembled. Be sure you have the proper termination, splice or power feed kits required for the installation. Be sure you have the following tools required and some aluminum foil tape to hold the sensors in place:

- Sharp knife or wire stripping tool.
- Side cutters.
- 25mm (*1 in*) adjustable wrench.
- Propane torch such as Thomas and Betts SIT-1 or equivalent heat source.
- Thomas and Betts crimping tool.

#### **INSTALLATION OF A1333-COJ TERMINATION KIT.**

Power and end termination kit contains the following components:

- One strain relief connector including two form fitting bushings of different sizes.
- One 13 mm (*1/2 in*) locknut.
- One 90 cm (*36 in*) roll of Teflon® tape.
- One blue insulated butt splice connector for #14-16 AWG wires.
- 30 cm (*12 in*) of #14 AWG green grounding wire.
- One yellow insulated butt splice connector for #12 AWG wire.
- 30 cm (*12 in*) of #12 AWG green grounding wire.
- One heat shrink end cap.
- One heat shrink tube.

#### **INSTALLATION OF END TERMINATION KIT # E1336-COJ (INCLUDED IN TERMINATION KIT # A1333-COJ).**

Remote end termination kit contains the following components:









- Three heat shrink end caps.
- Three heat shrink tubes.
- One 90 cm (*36 in*) roll of Teflon® tape.

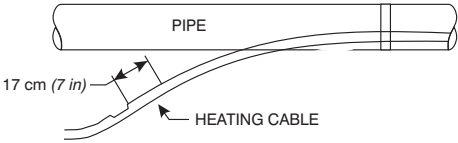
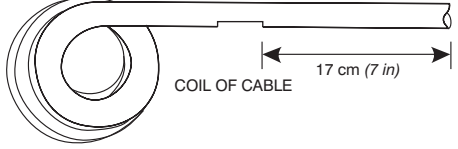

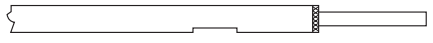
## TERMINATING THE THERMOCABLE®

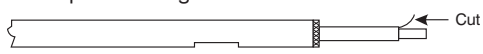
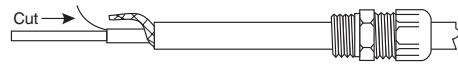
### IMPORTANT

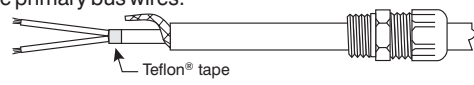
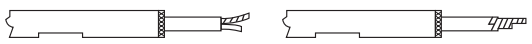
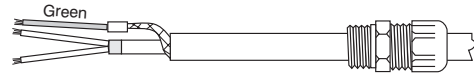
**THERMOCABLE® IS A PARALLEL HEAT TRACING SYSTEM – DO NOT CONNECT OR TIE COPPER BUS WIRES TOGETHER**

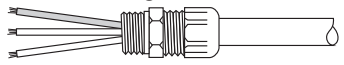
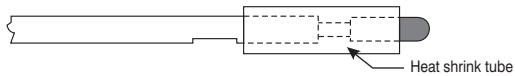
POWER TERMINATION	END TERMINATION
<p>① At the supply end allow sufficient cable to reach the junction box, plus approximately 20 cm (8 in) for connection tails. Cut approximately 17 cm (7 in) from indentation.</p> 	<p>① Cut cable approximately 17 cm (7 in) from indentation, as shown.</p> 
<p>② Choose the appropriate form fitting bushing to suit the THERMOCABLE® size. Use the bushing with the small opening for C8-120-COJ and the one with the larger opening for all the other THERMOCABLE®. Insert the bushing into the connector body, put the compression ring over the bushing and screw on the nut.</p> 	<p>② Remove 10 cm (4 in) of overjacket by scoring around and down the middle of the jacket. Unravel the braid and cut it close to the overjacket. Caution, do not cut into the insulating sheath.</p> 
<p>③ Slide the strain relief connector over the cable.</p> <p>④ Remove 20 cm (8 in) of overjacket by scoring around and down the middle of the jacket. Unravel the braid and twist into a pigtail. Caution, do not cut into the braid and insulating sheath.</p> 	<p>③ Cut back the layer of insulating sheath approximately 13 mm (1/2 in). On cables with a fiberglass rope, remove the rope by unwinding it all the way against the insulation and cut. Remove the spiral heating wire and cut.</p> 
<p>⑤ Remove the insulating sheath for approximately 15 cm (6 in). On cables with a fiberglass rope, remove the rope by unwinding it all the way against the insulation and cut. Remove the exposed nichrome heating wire back to the center layer of insulation and cut. Take care not to cut through the insulation on the bus wires. Apply Teflon® tape over no more than 10 mm (3/8 in) on each of the insulating sheath and inner insulation to insulate the bare nichrome element wire end.</p> 	<p>④ Cut back the layer of inner insulation jacket and remove to expose the two insulated bus wires. Cut 7 mm (1/4 in) from the bus wire on the indentation side.</p> 
<p>⑥ Remove the inner insulation jacket by sliding the knife blade between the two bus wires up to the taped position. Do not nick or cut the primary bus wires.</p> 	<p>⑤ Wrap the Teflon® tape around each conductor and over a maximum of 10 mm (3/8 in) of the insulating sheath taking care to cover the ends of the conductors and overlapping the tape to a minimum of half its width. <b>DO NOT CONNECT THE TWO BUS WIRES TOGETHER, THIS WILL CAUSE A SHORT CIRCUIT.</b></p> 
<p>⑦ On C8-120-COJ THERMOCABLE®, using the blue butt splice, connect the #14 AWG green wire supplied to the pigtail. On the other THERMOCABLE®, use the yellow butt splice to connect the #12 AWG green wire supplied to the pigtail. Remove 7 mm (1/4 in) of insulation from each wire end. Use an approved tool to crimp the butt splice connector.</p> 	<p>⑥ Slide the expanded heat shrinkable cap over the end of the cable. Shrink the cap by applying heat from the closed end towards the open end. Cap starts to shrink at 135 °C (275 °F). As heat is applied move the heat source around the cap to ensure even shrinkage. When the cap has shrunk enough to conform to the cable, and sealant is seen to flow, discontinue heating.</p> 
<p>⑧ Slide the strain relief connector into position and connect into a thermostat or junction box. Tighten the connector to compress the bushing.</p> 	<p>⑦ Slide the heat shrink tube over the end cap, grounding braid and overjacket, leaving 12 mm (1/2 in) of the end cap protruding. Shrink into place to seal the over jacket and end cap.</p> 

## INSTALLATION OF # S1334-COJ SPLICE KIT.





Splice kit contain the following components :

- One 90 cm (36 in) roll of Teflon® tape.
- Four blue insulated butt splice connectors for #14-16 AWG wires.
- 30 cm (12 in) of #14 AWG green grounding wire.
- Four yellow insulated butt splice connectors for #12 AWG wire.
- 30 cm (12 in) of #12 AWG green grounding wire.
- One short heat shrink tube 20 cm (8 in) long.
- One long heat shrink tube 30 cm (12 in) long.

## SPLICING PROCEDURE FOR THERMOCABLE®:

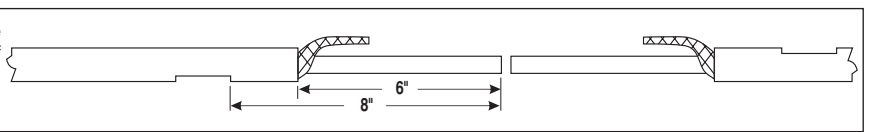
Locate the nichrome heating wire connection nodes, be sure to cut the strip at the correct location as per the following diagram to avoid possible 'dead zones'.

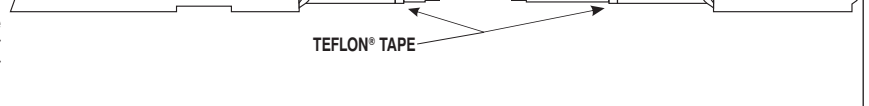
### SPLICING PROCEDURE:

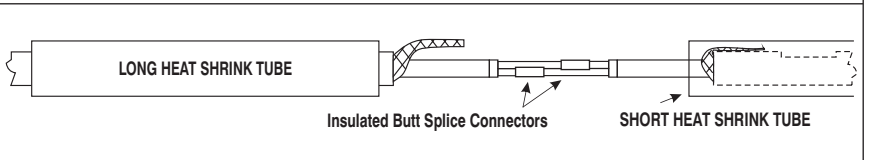
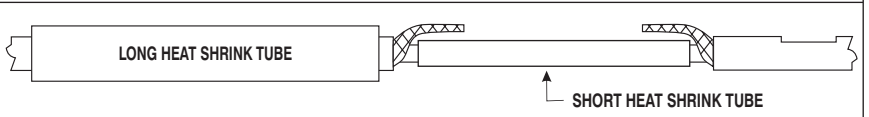
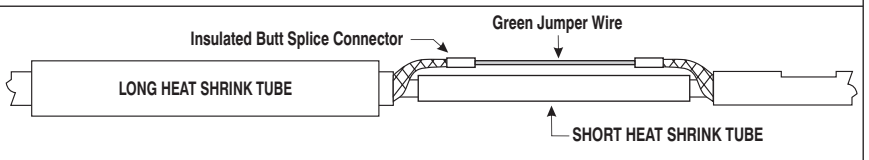
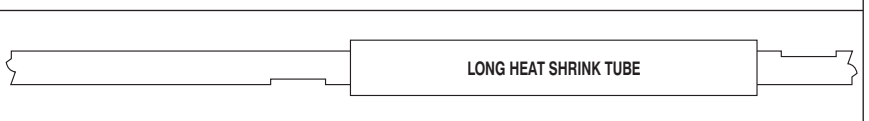
<p>① Cut cable 20 cm (8 in) from the heater zone indent and remove 15 cm (6 in) of overjacket by scoring around and down the middle of the jacket. Caution, do not cut into the braid and insulating sheath. Unravel the braid and twist into a pigtail. Repeat the same for the end of the other cable to be spliced.</p>	
<p>② Remove 7 cm (3 in) of insulating sheath. Prepare cable ends by removing the fiberglass rope (on cables having one) and the exposed nichrome heating wire back to the insulating sheath and cut. Take care not to cut through the insulation on the bus wires.</p>	
<p>③ Cut one alternate bus wire on each cable to 3 cm (1 in). Remove 7 mm (1/4 in) of insulation from each wire end. Apply Teflon® tape over no more than 10 mm (3/8 in) on each of the insulating sheath and inner insulation to insulate the bare nichrome element wire end.</p>	
<p>④ Slide the long heat shrink tube over the end of one cable and push it back 30 cm (12 in) out of the way.</p>	
<p>⑤ Slide the short/smaller diameter heat shrink tube over the bus wires and braid of the other cable end.</p>	
<p>⑥ Position the insulated butt splice connectors over the copper bus wires and crimp into place. Use an approved installation tool for the installation of the crimp connectors. <b>Note : Use the blue butt splice connectors only on C8-120-COJ THERMOCABLE® and use the yellow butt splice connectors on all other THERMOCABLE® having #12 AWG bus wires.</b></p>	
<p>⑦ Slide the short heat shrink tube up and center over the butt splices. Shrink into place.</p>	
<p>⑧ Join the two pigtailed braids directly, or with the green jumper wire using the butt splice connectors. Here again the blue butt splices and #14 AWG wire are used only on C8-120-COJ and the yellow butt splices and #12 AWG wire are used on all other THERMOCABLE® having #12 AWG bus wires.</p>	
<p>⑨ Slide the long heat shrink tube over the entire spliced assembly , center it and shrink into position.</p>	

## INSTALLATION OF # PS1337-12-COJ POWER FEED SPLICE KIT (FOR ALL CABLES EXCEPT C8-120-COJ)

Power feed splice kit contain the following components :

### For the splice :

- One 90 cm (36 in) roll of Teflon® tape.
- Three yellow insulated butt splice connectors for #12 AWG wire.
- One short heat shrink tube 20 cm (8 in) long.
- One long heat shrink tube 30 cm (12 in) long.
- One heat shrink end cap.

### For the end termination (see page 9):

- One heat shrink tube 15 cm (6 in) long.
- Heat shrinkable patch 2.6 cm x 5.7 cm (1 in x 2 1/2 in).

### For the sensor(s):

(See installation instruction #3E)

- Aluminum tape 5.0 cm (2 in) x 1 m (3.28 ft)

## PROCEDURE TO SPLICE THERMOCABLE® TO POWER WIRING:

Locate the nichrome heating wire connection node, be sure to cut the heating cable at the correct location as per the following diagram to avoid unnecessary “dead zone”. Use approved # 12 AWG 600 V insulated wiring such as TEW, RW90 or RWU90 of the appropriate length to splice to the THERMOCABLE®.

### SPLICING PROCEDURE :

<p>1 Cut cable 20 cm (8 in) from the heater zone indent and remove 15 cm (6 in) of overjacket by scoring around and down the middle of the jacket. Caution, do not cut into the braid and insulating sheath. Unravel the braid and twist into a 5 cm (2 in) long pigtail.</p>	
<p>2 Remove 7 cm (3 in) of insulating sheath. Prepare cable ends by removing the fiberglass rope (on cables having one) and the exposed nichrome heating wire back to the insulating sheath and cut. Take care not to cut through the insulation on the bus wires.</p>	
<p>3 Cut one bus wire to 3 cm (1 in). Remove 7 mm (1/4 in) of insulation from each bus wire end. Apply Teflon® tape over no more than 10 mm (3/8 in) on each of the insulating sheath and inner insulation to insulate the bare nichrome element wire end.</p>	
<p>4 Slide the long heat shrink tube over the end of the heating cable and push it back 30 cm (12 in) out of the way.</p>	
<p>5 Slide the short/smaller diameter heat shrink tube over the two power wires and push it back out of the way.</p>	
<p>6 Position the yellow insulated butt splice connectors over the heating cable bus wires and #12 AWG power wires and crimp into place. Use an approved installation tool for the installation of the crimp connectors.</p>	
<p>7 Slide the short heat shrink tube over the splices and center over the assembly. Shrink into place.</p>	
<p>8 Splice the pigtailed braid to the #12 AWG grounding wire using a yellow insulated butt splice connector.</p>	
<p>9 Remove the protective liner on the heat shrinkable patch. Position over the three insulated power wires, adhesive side against the wires, at the end of the small heat shrink tube already in place and wrap around the wires so that it overlaps over itself.</p>	
<p>10 Slide the long heat shrink tube over the entire spliced assembly, center it and shrink into position.</p>	

